

Exterior Bollard LED

EB3036
INSTALLATION SHEET

START FROM HERE

- Make sure **POWER** is **COMPLETELY OFF** at the fuse box
- Have your fixture installed by a qualified licensed electrician
- Prepare everything in a clear area
- Wear gloves at all time during this installation
- Read instructions carefully before you start assembly
- Keep this installation sheet for future reference

Please Note:

- This Kuzco LED fixtures come with pre-wired LED module(s)
- Unless instructed, Do Not touch any part of the LED module(s) as any unnecessary contact with the module could cause permanent damage
- 120~277V input
- Non-Dimming

Technical Support: 1-855-855-8926

- 1.** Remove fixture from its original package
- 2.** Provide means to bring supply wiring to bollard in accordance with local code before pouring concrete
- 3.** Secure anchor bolts (**1c**) to mounting guide plate (**1e**) with hex nuts and washers provided (**1d**) before concrete cures (**illustration 1**)
- 4.** After concrete is set, replace mounting guide plate (**1e**) with mounting base (**2b**), adjust mounting base to desired orientation and secure with hex nuts and washers (**1d**)
- 5.** Pull conduit through base plate to make proper electrical connection (black to hot "L", white to neutral "N", ground to "GND") with wire nuts (**1b**) provided in hardware package, tie access wires to avoid contact with ground
- 6.** Align interior bump on fixture (**1a**) with slot on mounting base (**2b**) (**illustration 2**), rotate to desired orientation, and secure fixture (**1a**) to mounting base (**2b**) with set screw (**2a**) with allen key provided

Illustration 1

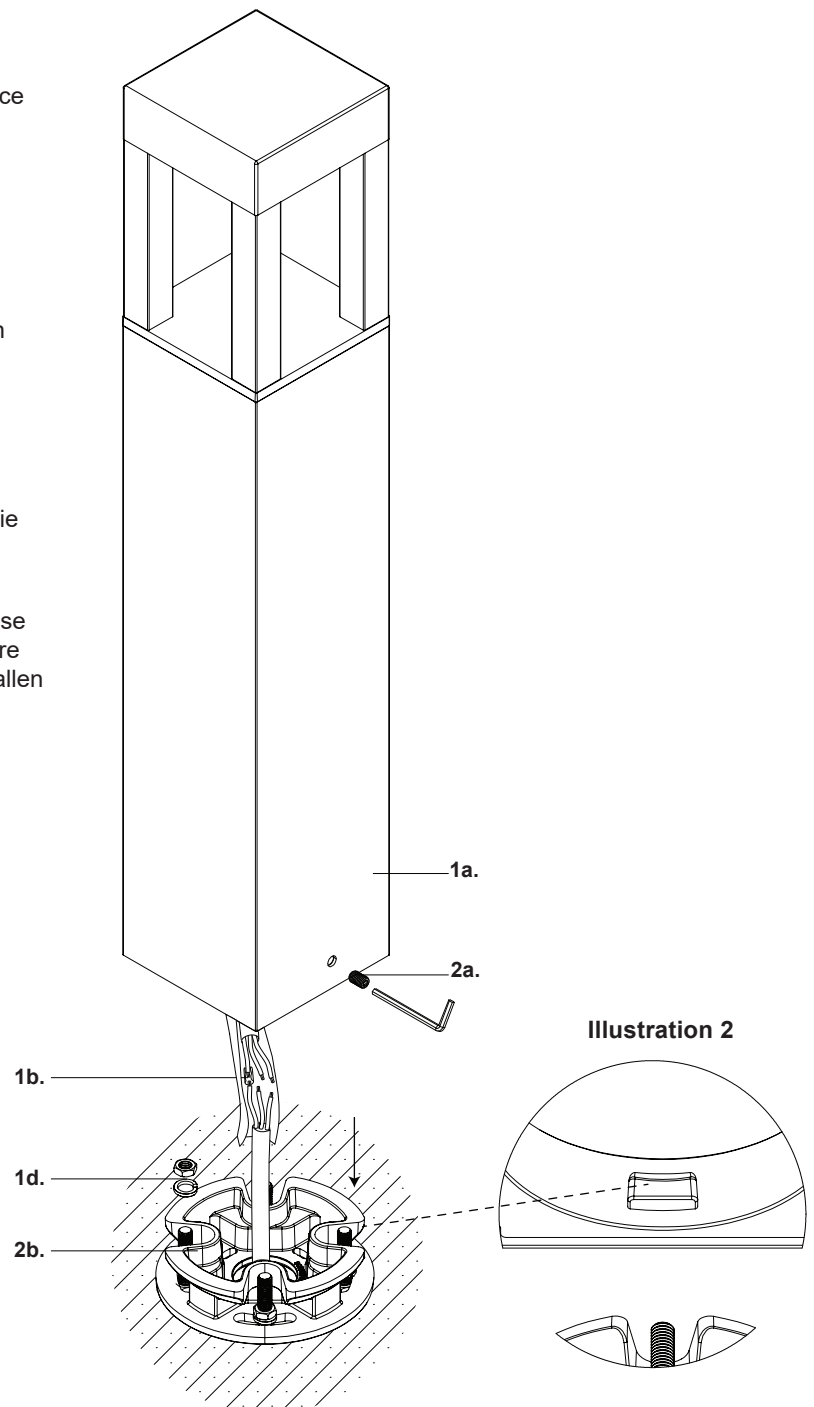
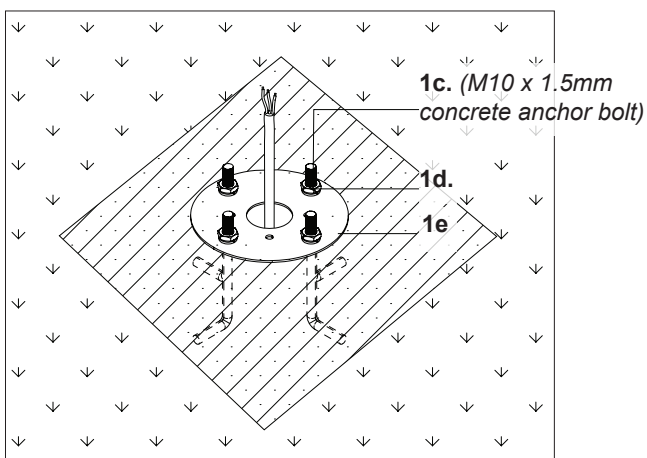

Illustration 2

KUZCO

19054 28th Avenue Surrey, BC Canada V3Z 6M3
T: 604 538 7162 TF: 1-855 85 KUZCO F: 604 538 7196
W: kuzcolighting.com
20220506

START FROM HERE

- Make sure **POWER** is **COMPLETELY OFF** at the fuse box
- Have your fixture installed by a qualified licensed electrician
- Prepare everything in a clear area
- Wear gloves at all time during this installation
- Read instructions carefully before you start assembly
- Keep this installation sheet for future reference

Please Note:

- This Kuzco LED fixtures come with pre-wired LED module(s)
- Unless instructed, Do Not touch any part of the LED module(s) as any unnecessary contact with the module could cause permanent damage
- 120~277V input
- Non-Dimming

Technical Support: 1-855-855-8926

Mounting Guide Template

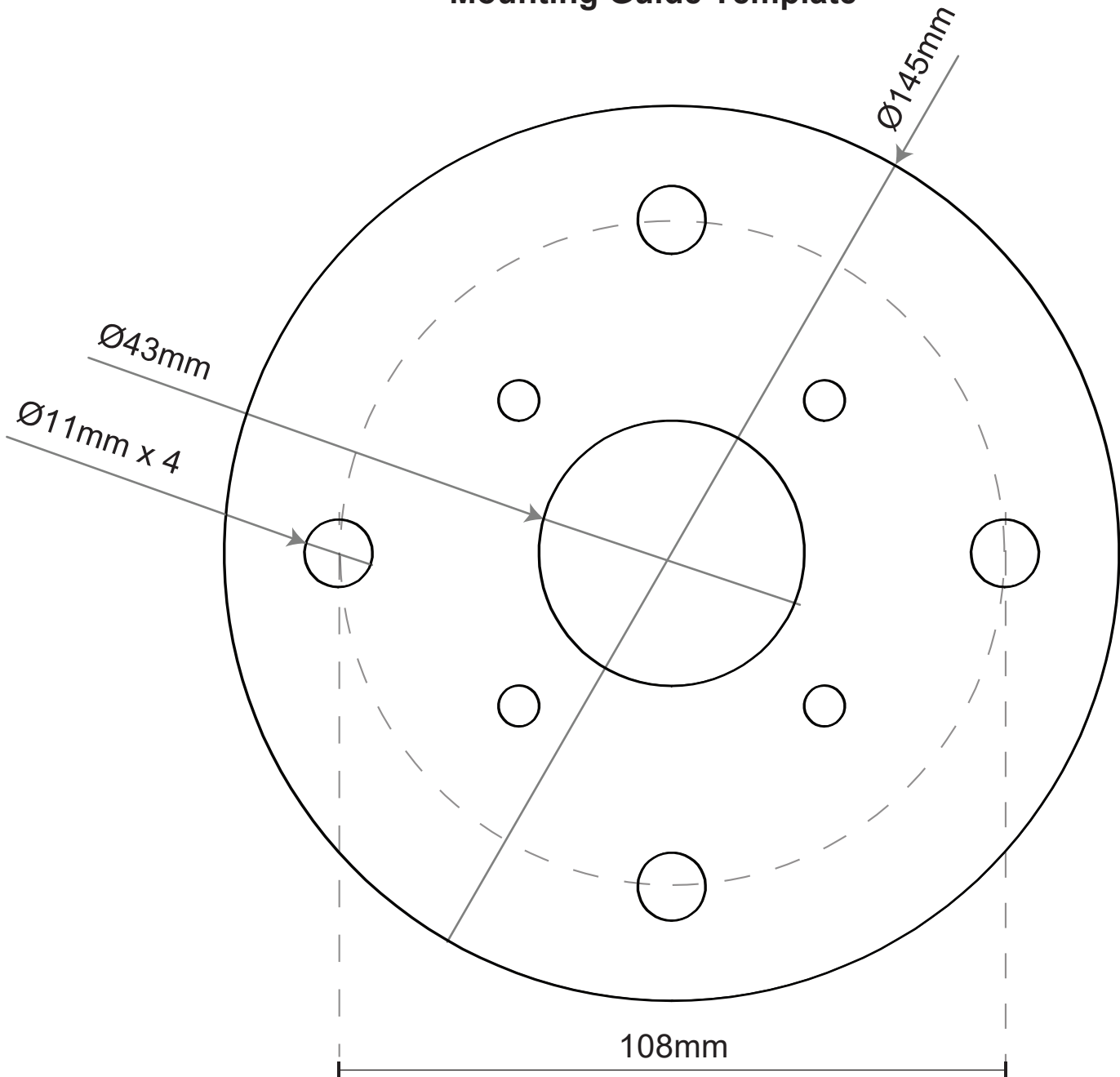

KUZCO

19054 28th Avenue Surrey, BC Canada V3Z 6M3
T: 604 538 7162 TF: 1-855 85 KUZCO F: 604 538 7196
W: kuzcolighting.com
20220506